

SphèrAléas

Tridimensional interactive / sound / image / installation

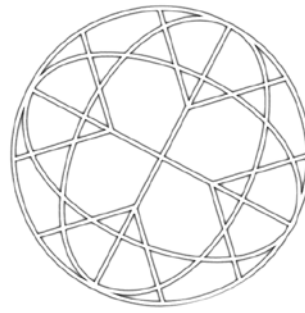

www.scenocosme.com

Scenocosme : Grégory Lasserre & Anaïs met den Ancxt
scenocosme@gmail.com Tel: +33(0)661095052

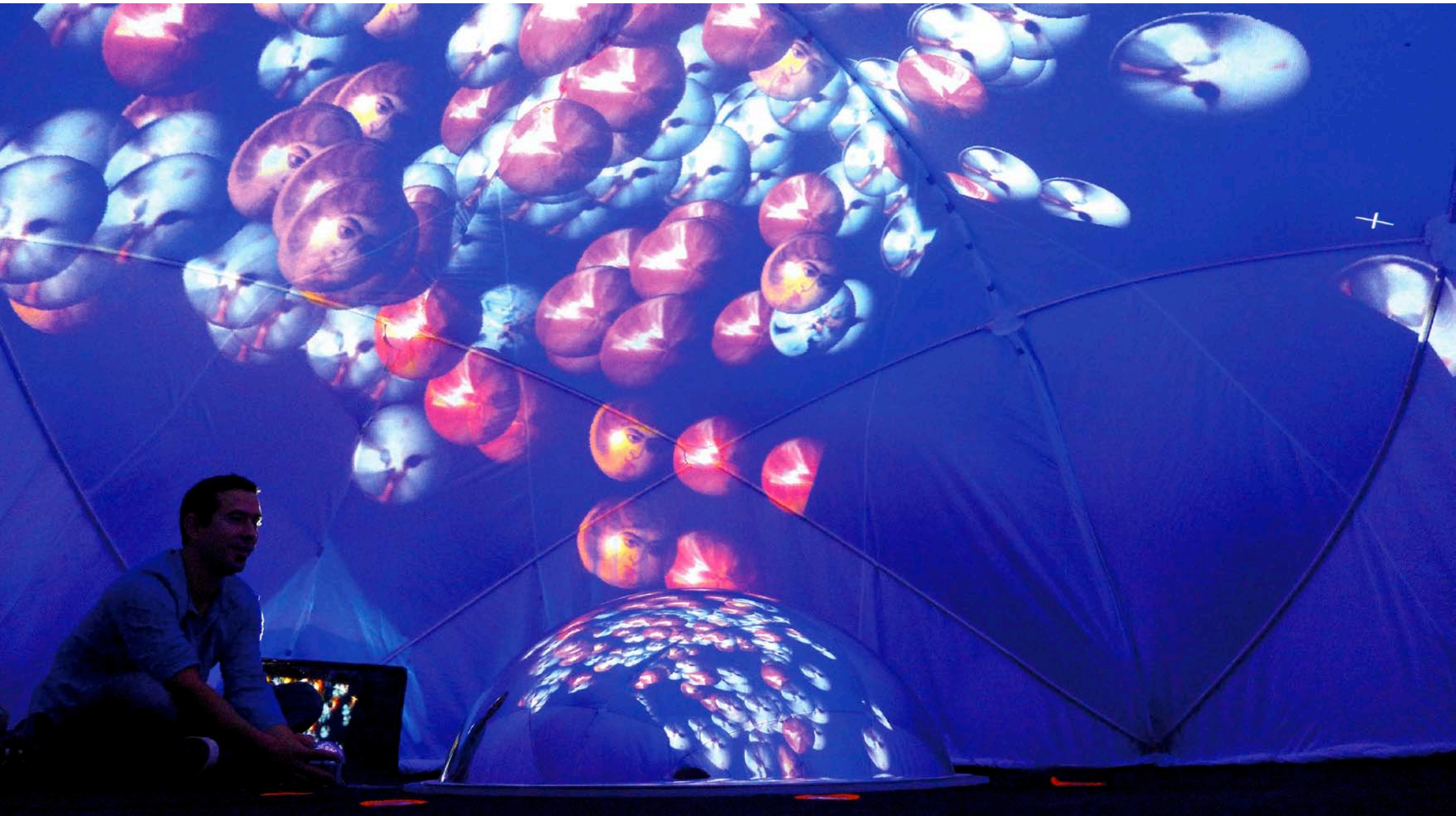



Fête des Lumières de Lyon / Église Saint-Bruno-les-Chartreux - Lyon (Fr)

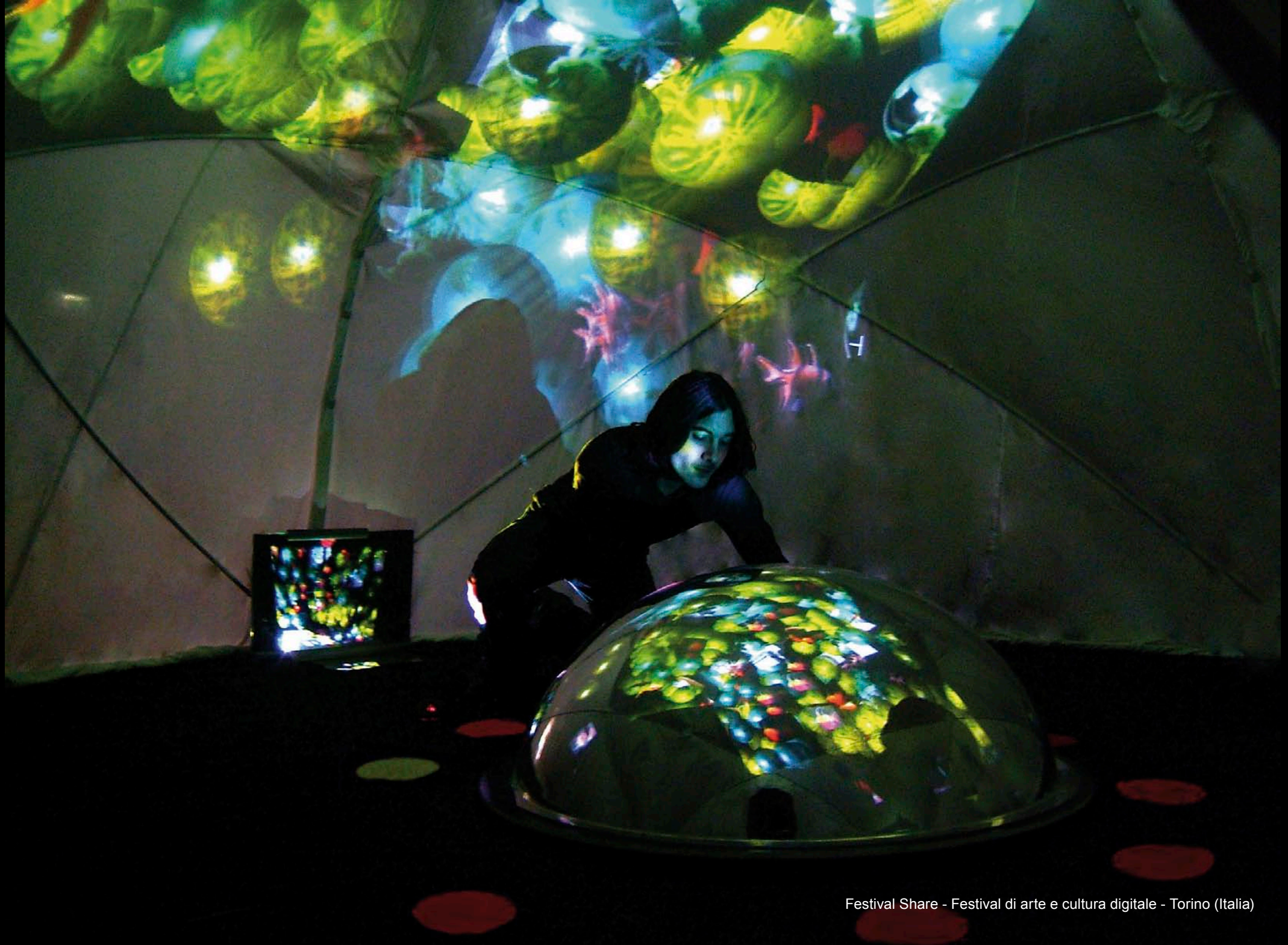

Interactive and immersive space / collective performances

SphèrAléas is made of a half-spherical structure and of an evolutionary device which makes man, image and sound interact thanks to digital tools. SphèrAléas is ideal for collective performances. It's a safe space of oneiric creations in which the public creates, handles, juxtaposes, superimposes sonorous, pictorial shapes unstable and reactive.

Like for the learning of a musical instrument, people must take time to experiment it. Collectively, they must pay particular attention to compose a melody. Spectators are sitting around a hearth which is materialized by a hemispherical mirror. They can manipulate sensitive device in order to create visual and sonorous symphonies. By manipulating the sensors, the spectator-musician can continuously intervene on the whole structure by playing with the different variables: order, side-by-side positioning, overlapping, speed, rhythm, harmonic pitch... It is a kind of orchestra : there is a conductor who guides musicians, and coordinates the organization of visual and sonorous objects.

The scenography is designed for complete immersion of the spectator thanks to interactive sensors, a multipoint sound diffusion, a video projection system (180°), within a half spherical membranous architecture. This original shared experiment becomes a poem of sensations: inside this womb-like space, sensitive perceptions are amplified, modified until a multitude of unexpected metaphorical worlds resonate.

The show is ever changing...

More information and video : www.scenocosme.com/spheraleas_e.htm

This work has received the support from
CNC : bourse DICREAM Dispositif pour la Création Artistique Numérique
Région Rhône-Alpes, ville de Lyon, MGcréation, Médias-Cité



Interactive and immersive device

Designed for real-time musical and visual interactions, the immersive space is a semi-transparent half-sphere, 2.50 meters-high (8.2 feet-high). This structure is used as a screen for wide-angle projection similar to that of planetariums.

Then the audience can be totally immersed in unreal and captivating atmospheres.

Speakers and amplifiers make possible games of spatialisation of sound. Inside the dome, the audience, seating or lying, can manipulate sensitive device and sensor sensors or simply daydream. These manipulations are interpreted by the Aléas software which produces the sound and the 3D compositions. By mixing these image and sound structures, like an orchestra, spectators create symphonies to contemplate.

Aléas : original virtual music software/instrument

Aléas arose from a reflection about how to materialise/draw sound with 3D images. It is a synthesis software, treating sounds and abstract images, able to create a dialogue with reality by using tactile sensors. It creates therefore an interactive, sensitive relationship with the audience.

It allows to create, modify, observe and manipulate moving 3D shapes. Each picture is associated to a sound. It allows to visualize the sonorous score when audience is playing

By positioning new materials, users create sustained melodies made of rhythmic relationships animated by subtle temporal intervals. Each user appropriates the system by creating particular processes of repetitive polyphony where parts overlap then disappear into hypnotic swirls. The audience determines the future of the work by experimenting with infinite orchestrations. They control easily the melodie thus generated.

Other sensitive and interactive sonorous artworks

Metamorphose : www.scenocosme.com/metamorphose_e.htm

Maison sensible : www.scenocosme.com/maison_sensible_e.htm

SphérAléas : www.scenocosme.com/spheraleas_e.htm

Ecorces : www.scenocosme.com/ecorce_e.htm

Fluides : www.scenocosme.com/fluides_e.htm

Lights Contacts : www.scenocosme.com/contacts_installation_en.htm



Scenocosme : Grégory Lasserre & Anaïs met den Ancxt : www.scenocosme.com

The couple artists Gregory Lasserre and Anaïs met den Ancxt work under the name Scenocosme. They live in the Rhone-Alpes region in France. Their singular artworks use diverse expressions: interactive installations, visual art, digital art, sound art, collective performances etc.... Scenocosme mix art and digital technology to find substances of dreams, poetry, sensitivity and delicacy. These artists overturn various technologies in order to create contemporary artworks. Their works came from possible hybridizations between the technology and living world (plants, stones, water, wood, humans,...) which meeting points incite them to invent sensitive and poetic languages. The most of their interactive artworks feel several various relationships between the body and the environment. They can feel energetic variations of living beings and design interactive stagings in which spectators share extraordinary sensory experiences. Their artworks are exhibited in numerous museums, contemporary art centres and digital art festivals in the world.

They have exhibited their interactive installation artworks at ZKM Karlsruhe Centre for Art and Media (Germany), at Daejeon Museum of Art (Korea), at Museum Art Gallery of Nova Scotia (Canada), at National Centre for Contemporary Arts (Moscow), at Contemporary Art Museum Raleigh (USA), at Bòlit Centre d'Art Contemporani (Girona) and in many international biennals and festivals : Art Center Nabi / INDAF (Seoul), BIACS3 / Biennial International of Contemporary Art of Seville (Spain), Biennial Experimenta (Australia), NAMOC / National Art Museum of China / TransLife / Triennial of Media Art (Beijing), C.O.D.E (Canada), Futuresonic (UK), WRO (Pologne), FAD (Brasil), ISEA / International Symposium on Electronic Art (2009 Belfast, 2011 Istanbul, 2012 Albuquerque, 2013 Sydney), EXIT, VIA, Lille3000, Ososphere, Scopitone, Seconde nature (France)... during important events : World Expo (Shanghai), Nuits Blanches (Toronto, Halifax, Bruxelles, Brighton, Amiens, Segovia, Bucharest), Fête des lumières (Lyon)... and in various art centers : MONA (Australia), MUDAC, Fondation Claude Verdan (Lausanne), Musée Ianchelevici (Belgium), Kibla (Slovenia), Banff Centre (Canada), Villa Romana (Firenze), Utsikten Kunstsenter (Norway), Watermans (UK), Centre des arts d'Enghien-les-Bains, Gaîté Lyrique (Paris) etc.

Full biography : www.scenocosme.com/PDF/scenocosme_BOOK_EN.pdf

Wikipedia : <https://en.wikipedia.org/wiki/scenocosme>



Antico palazzo di Città - Mondovi (Italia)



Théâtre de la ville de Valence (Fr)

Previous exhibitions of SphèrAléas

- **Festival Share** - Festival di arte e cultura digitale / Curator : Chiara Garibaldi, Luca Barbeni - Torino (**Italia**)
- **Antico palazzo di Città** - Mondovi (**Italia**)
- **SMIR** Spazi Multimediali per l'Innovazione e la Ricerca / Curator : Chiara Garibaldi, Luca Barbeni
- **Festival International VAD** / Video And Digital Arts- Girona (**Spain**)
- **Festival Olala** / Church Spitalskirche - Lientz (**Austria**)
- **Museo de Arte Contemporáneo Esteban Vicente** - Segovia (**Spain**)
- **Noche de Luna Llena** - Segovia (**Spain**)
- **ACM Multimedia Interactive** / Interactive Art Exhibition - Augsburg (**Germany**)
- **Festival Ososphere** - Strasbourg (Fr)
- **Festival Arborescence** - Aix en Provence (Fr)
- **Festival Scopitone** - Nantes (Fr)
- **Festival Nuits-Sonores** - Lyon (Fr)
- **Festival TILT / El mediator Salle de Musiques Actuelles-** Perpignan (Fr)
- **Festival N.A.M.E.** / Chapelle des Sœurs Noires - Maubeuge (Fr)
- **Festival N.A.M.E. / Le Tripostal** - Lille (Fr)
- **Festival AADN** / Arts et Cultures Numériques - Lyon (Fr)
- **Festival d'art numériques Digitalis** - Mende (Fr)
- **Festival Electrochoc** / Les Abattoirs - Bourgoin-Jallieu (Fr)
- **Festival Les Féeries nocturnes** - Embrun (Fr)
- **Festival duch'air(e)** - Lyon (Fr)
- **Festival place à l'insolite** - Sevrier (FR)
- **Festival L'enfance de l'art** / Hotel de ville - St Julien-en-Genevois (Fr)
- **Château de Suscinio** / Réverie Moderne / L'Echonova Lieu de Musiques Actuelle- Sarzeau (Fr)
- **Abbaye de Noirlac** - Centre culturel de rencontre - Noirlac (Fr)
- **Abbaye de l'Escaladieu** - Horizons numériques - Bonnemazon (Fr)
- **Fête des Lumières de Lyon** / Église Saint-Bruno-les-Chartreux - Lyon (Fr)
- **Fête des Lumières de Valence** / Théâtre de la ville de Valence (Fr)
- **Nuit Blanche** - Amiens (Fr)
- **Musée départemental de Préhistoire d'Ile-de-France** - Nemours (Fr)
- **Centre culturel Condorcet** / Festival Mon Œil ! - Viry-Chatillon (Fr)
- **Centre culturel René Char** - Digne les Bains (Fr)
- **Centre culturel Le Carré des Jalles** / Médias-Cité - St Médard en Jalles (Fr)
- **Centre culturel de Taverny** - Taverny (Fr)
- **Centre culturel Bellegarde** - Toulouse (Fr)
- **Centre culturel Saint-Exupéry de Reims** / Programme hors les murs
- **La pellicule ensorcelee** / Relais de Poste de Launois-sur-Vence - Launois-sur-Vence (Fr)
- **Espace M. Achard** - Sainte Foy-lès-Lyon (Fr)
- **Espace Baudelaire** - Rillieux la Pape (Fr)
- **Espace culture multimédia Les Carrés** - Annecy (Fr)
- **Espace culture multimédia Raimon Trencavel** - Béziers (Fr)
- **Médiathèque de Saint-Etienne** (Fr)
- **Médiathèque de Camponac** - Pessac (Fr)
- **Maison Folie hospice d'Havré** - Tourcoing (Fr)
- **Maison Folie La Ferme d'en haut** - Villeneuve-d'Ascq (Fr)
- **Scène Nationale Le Moulin du Roc** - Niort (Fr)
- **Scène de Musiques Actuelles Le 106** - Rouen (Fr)
- **Scène de Musiques Actuelles L'Olympic** - Nantes (Fr)

Previous representations

- GA International Conference on Generative Art - Milan (Italia)
- Salon Internacional de Arte Digital - La Habana (Cuba)
- International Conference on 3D Technology - Maryland (USA)
- Festival Emergences / Maison de La Villette - Paris (Fr)

Awards and nominations

- **Bourse du CNC : DICREAM Dispositif pour la Création Artistique Numérique** (Fr)
- Award Top Talent Quality Seal - Europrix Multimedia : Vienna (Austria)
- Quartz Electronic Music Awards : Nominated for Quartz Hybrid - Paris (Fr)
- Trophées Laval Virtual : Nominated - Laval (Fr)
- SIGGRAPH Selected for Art Gallery - San Diego (USA)

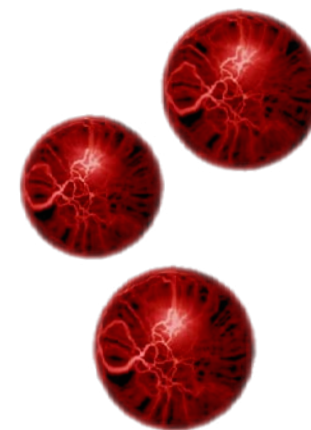

Technical information

The installation is provide with all the equipment.
(*video projectors, speakers, geodesic structure, computer, mirrors, etc.*)

Spatial requirment

A room with the following characteristics

- A room in the dark (The installation has this own light)
- Height: 2.50 metters (8.2 feet)
- Ground surface of the installation : more than 5m x 5m
More space is necessary around for circulation of the visitors
The work is more beautiful in a large space
- The installation diffuse sound
- Time for assembling : 8 hours
- Time for disassembling: 3 hours

Safety measures

The installation is protected against fire:
The carpet and fabrics are fireproofed.

SpherAleas
(view from top)

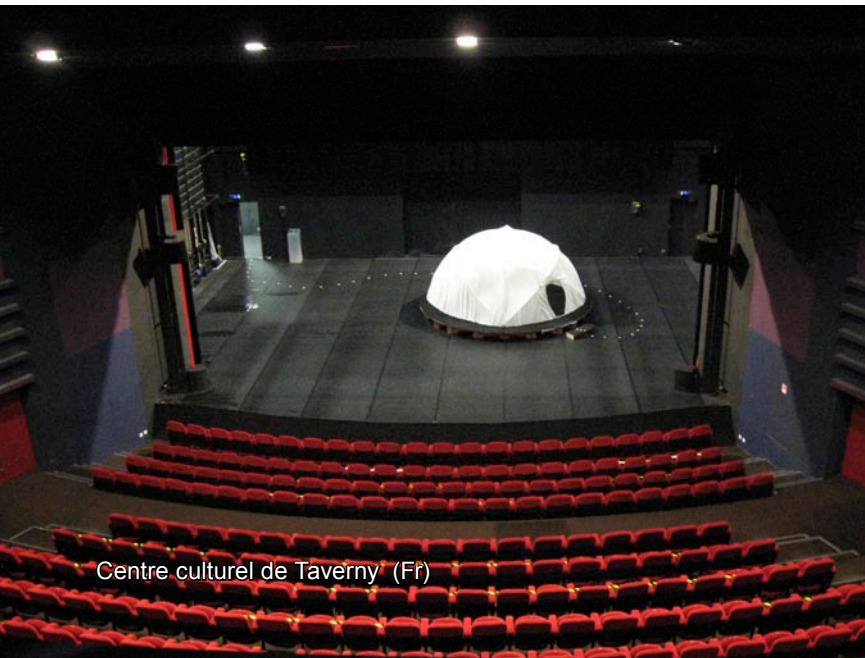
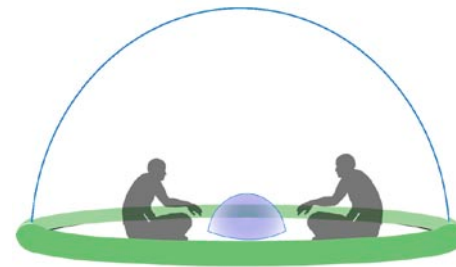
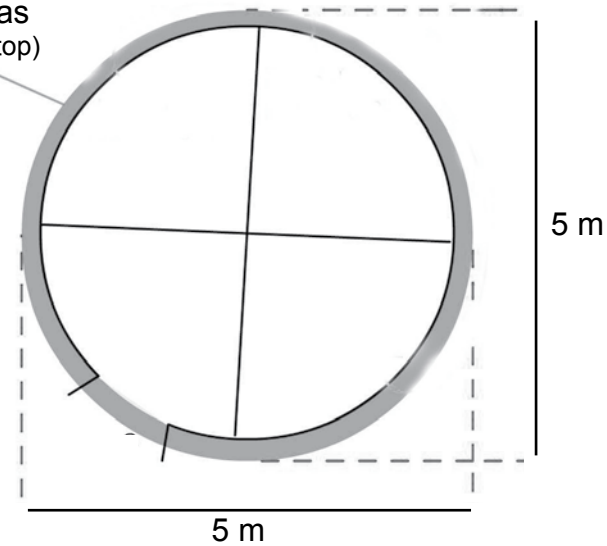

Centre culturel de Taverny (Fr)



Abbaye de Noirlac - Centre culturel de rencontre - Noirlac (Fr)



Fête des Lumières de Lyon
Église Saint-Bruno-les-Chartreux - Lyon (Fr)

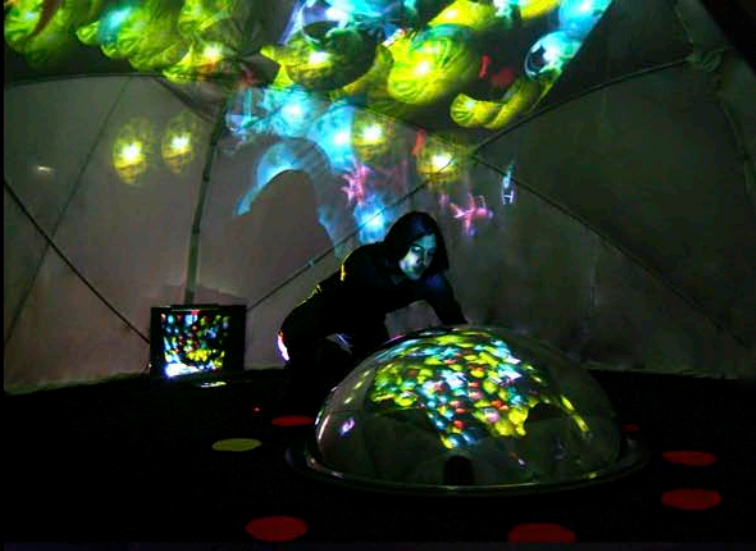
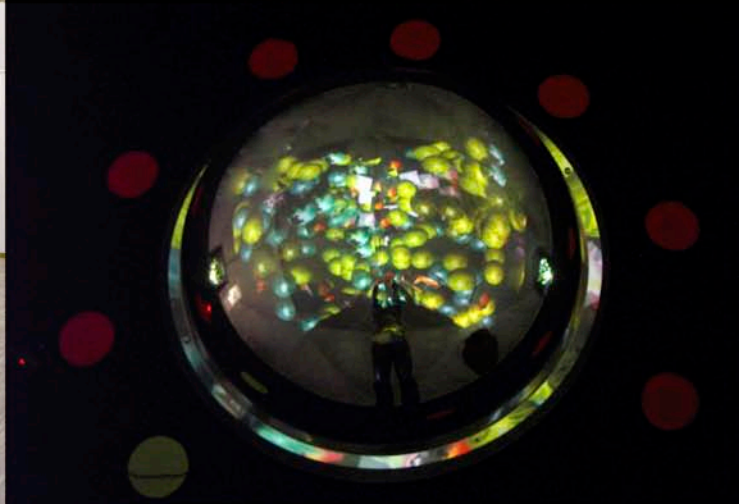
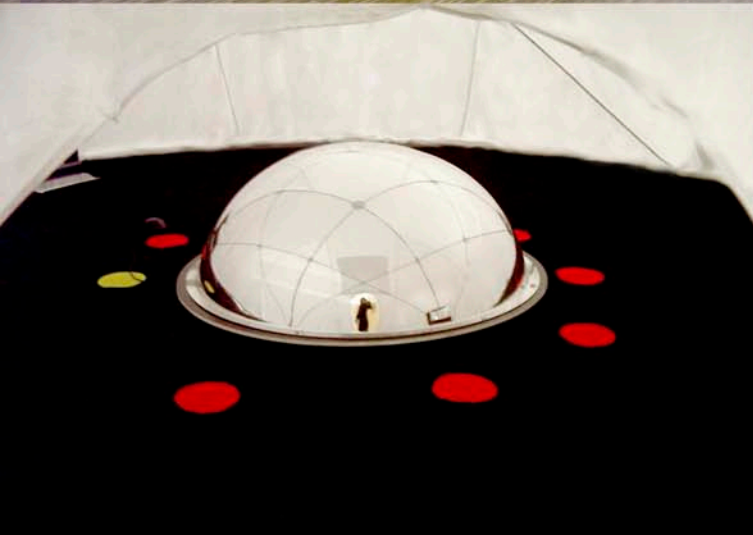
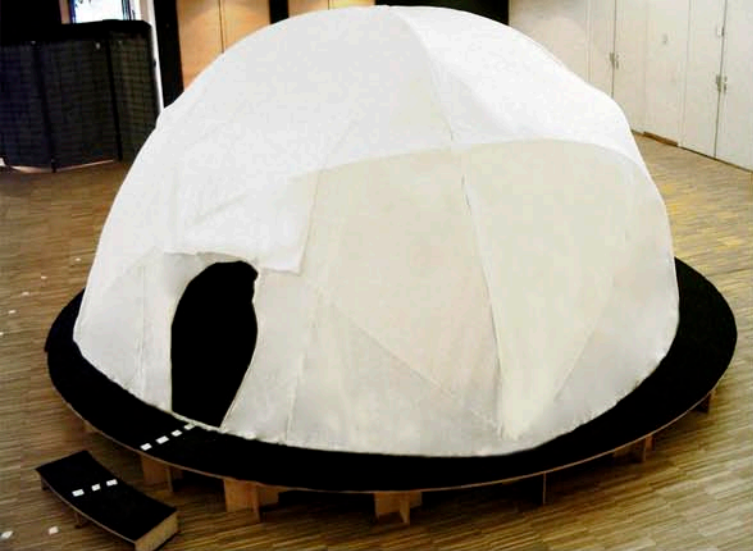



Cloître de la Maison Folie hospice d'Havré - Tourcoing (Fr)

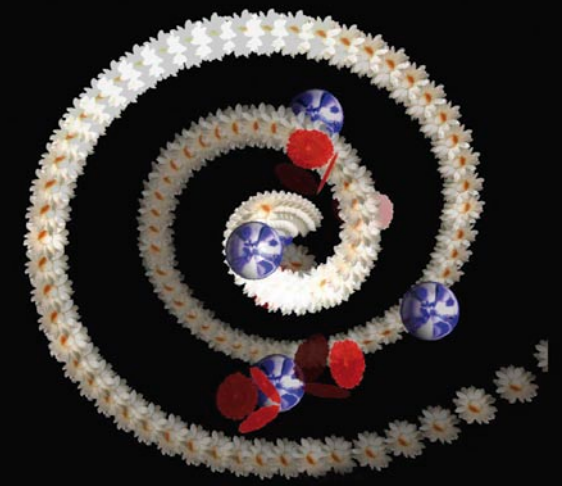
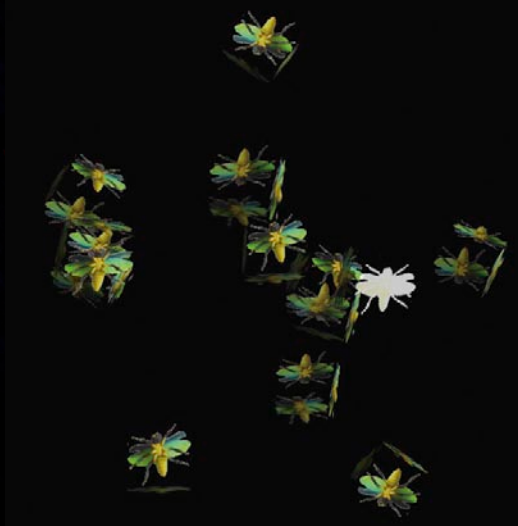
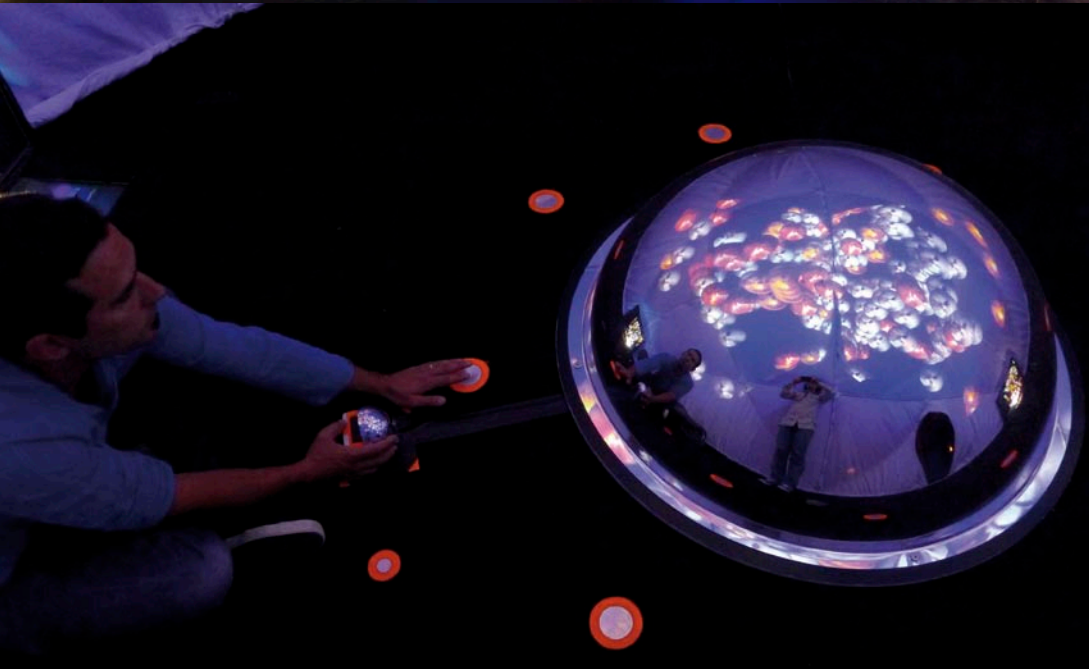
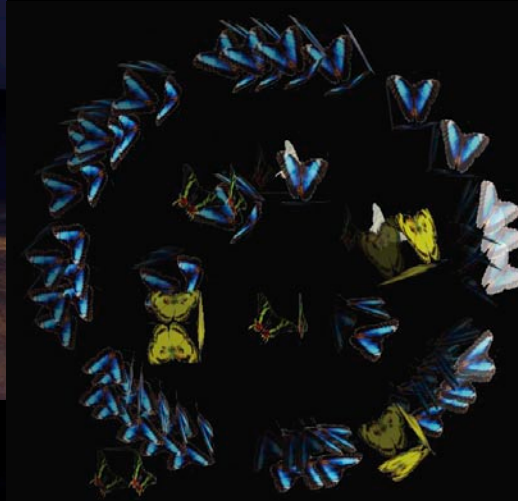
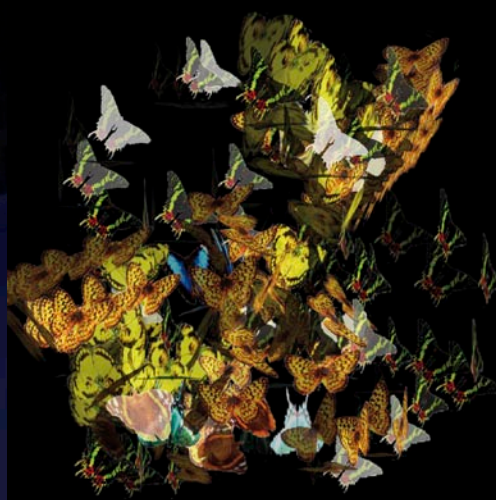



Festival Olala / Church Spitalskirche - Lienz (Austria)



Museo de Arte Contemporáneo Esteban Vicente / Noche de Luna Llena- Segovia (Spain)